

Replacing the paper roll

- Press the unlock area on the printer panel inwards. The printer drawer opens.
- Pull the printer drawer out of the printer.

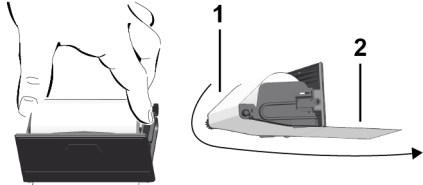

- Insert a new paper roll and guide it via the pulley (1).

IMPORTANT

Make sure that the paper roll in the printer drawer does not get jammed and the start of the paper roll (2) is visible under the edge of the printer drawer (tear-off edge).

- Push printer drawer into the printer compartment until it engages. The printer is ready for operation.

Messages

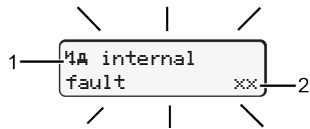

- (1) Pictogram of the message

- ! Event, example: [!⊗ drivins without valid card]
- × Fault, example: [×! Sensor malfunction]
- ⚠ Driving time warning, example: [⚠! Break !]
- ℹ Operational note, example: [ℹ! no paper]

- (2) Error code

Messages and measures: See operating instructions.

Acknowledge message:

- Press **OK** key 2 times: the message disappears.

Displaying the times of the driver card

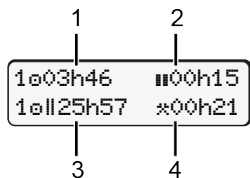

- (1) Driving time ⊗ since a valid rest time.
- (2) Valid rest time ⊥ in accordance with regulation (EC) 561/2006
- (3) Driving time over two weeks ⊙
- (4) Duration of the set activity

Calling up menu functions

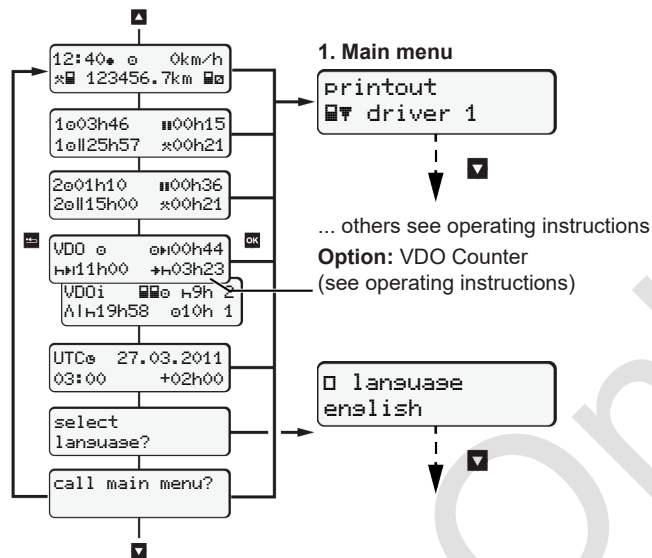

(Possible only when the vehicle is stationary)

- Use **▲** / **▼** to select the desired display.
- Use **OK** to call up the menu functions (second menu level).
- Use **▲** / **▼** to select the listed menus step by step.

Print daily value:

- [Printout **▼** driver 1]...[24h **▼** Daily value]... [25/10/2018]...[Printout in UTC Yes/No]

Enter "Out of scope" beginning / end:

- [Entry **A** vehicle]...[OUT **+** basin] or [**+** OUT end]

Enter "Ferry / train" beginning / end:

- [Entry **A** vehicle]... [**+** basin] or [**+** end]
- After [**+** basin] set the current activity.

Set Local time:

- [Entry **A** vehicle]...[⊗ local time]...
- Set Local time in steps of ± 30 minutes.

Reference to the operating instructions

IMPORTANT

These brief instructions shall not be regarded as a substitute for the exhaustive operating instructions for the DTCO 1381 prescribed by Regulation (EU) 2016/799, Annex IC.

Brief instructions for driver

DTCO[®] 1381 – Release 4.0
A2C19982500 / 41234727 OPM 000 AA



BA00.1381.40 500 102



www.fleet.vdo.com

Operational elements

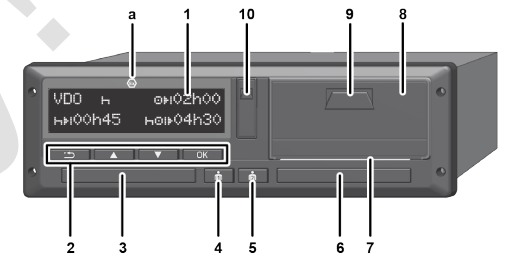

- (1) Display
 - (2) Menu buttons
 - ▲ / ▼ Select function
 - OK Confirm function
 - ⊗ Cancel menu
 - (3) Card slot 1
 - (4) Combination key Driver 1* (a) : ADR variant
 - (5) Combination key Driver 2*
 - (6) Card slot 2
 - (7) Tear-off edge printer
 - (8) Printer drawer
 - (9) Unlock area
 - (10) Download interface
- * Set activities or eject driver card

Displays during journey

- **▲** or **▼**: Switch to standard display.
- (1) Time (* = local time)
- (2) Operational mode operation
- (3) Speed
- (4) Activity, driver 1
- (5) Symbol driver 1
- (6) Odometer reading
- (7) Symbol driver 2
- (8) Activity, driver 2

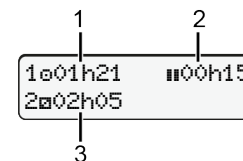
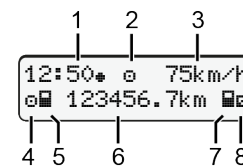

Standard display option VDO Counter – see operating instructions.

Insert driver card / Manual entries

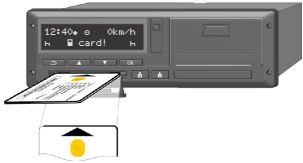

Driver 1 (driver) inserts his driver card into card slot 1

Always keep the card shafts closed – except for the insertion or removal of the driver card.

- Switch on the ignition in case of the ADR variant.
- Press the combination key Driver 1 for more than 2 seconds. The card slot opens.
- Open the card slot cover.
- Insert driver card into the card slot.
- Close card slot and push it in.
- Follow the menu guidance.

welcome
07:35* 05:35UTC

last withdrawal
15.04.18 16:31*

1M entry
addition? yes

Display: Local time 07:35* and UTC time 05:35UTC (Daylight saving time: + 2 hours).

The date/time of the most recent card withdrawal in local time (*).

Please ensure the continuous recording of the activities.

Yes: make manual entries.
No: Do **not** add activities/rest times

Example A: Add rest period

M 15.04.18 16:31
H 18.04.18 07:35

M 15.04.18 16:31
H 18.04.18 07:35

*? besin country
:UK

1M entry
Res. Number? yes

07:36* 0km/h
H 123456.7km H

Withdrawal (15.04.18)
16:31 Local time

Insertion (18.04.18)
07:35 Local time

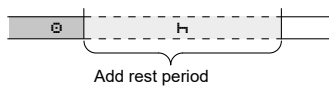

- Press and hold key : Jump to the last entry field (minutes blink).
- Press the key again.

Start country only when End country was entered during the last withdrawal.

- Acknowledge entry.
- = Trip can be started.

Example B: Continuing activity

M 24.02.18 23:32
H 25.02.18 02:30
* 25.02.18 02:30
* 25.02.18 00:20

M 25.02.18 00:20
H 25.02.18 02:30
□ 25.02.18 02:30

*? besin country
:UK
1M entry
entry? yes

02:31* 0km/h
H 123456.7km H

Example C: Continuing activity and preceding others with activity

M 05.11.18 17:50
H 14.11.18 14:00
* 05.11.18 18:45
M 05.11.18 18:45
*? end country

M 05.11.18 18:45
H 14.11.18 14:00
? 14.11.18 12:10
M 14.11.18 12:10
*? bes. country

M 14.11.18 12:10
H 14.11.18 14:00
□ 14.11.18 14:00

*? bes. country
:UK
Res. Number? yes

M 14.11.18 12:10
H 14.11.18 14:00
□ 14.11.18 14:00

*? bes. country
:UK
Res. Number? yes

14:01* 0km/h
H 123456.7km H

Withdrawal (24.02.18)
23:32 Local time

Insertion (25.02.18)
02:30 Local time

00:20 Local time

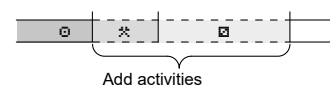

- Set, acknowledge activity *.
- Set, acknowledge day, hours, minutes.
- Set, acknowledge the next activity □.
- Press and hold key (the minutes blink).
- Press the key again.
- Acknowledge entry.

Withdrawal (05.11.18)
17:50 Local time

Insertion (14.11.18)
14:00 Local time

18:45 12:10

*? end country
:UK

*? bes. country
:UK

Use key in order to:

- abort the entry of a country
- select the possible variables (backspace) directly in the entry block.

When you insert a driver card for the first time and after the manual addition, you will be asked whether you agree to the processing of personal data. For details see operating instructions.

Withdrawing driver card

- Switch on the ignition in case of the ADR variants.
- Keep the corresponding combination key for more than 2 seconds.
- Follow the menu guidance.

*? end country
:E

E AN
15:05* 0km/h
H 123456.7km H

- Select, acknowledge the country.
- Spain: Select region.
- With button you can abort the entry of a country if you, for example, want to continue your work shift.
- The card shaft is opened to withdraw the driver card.
- Withdraw driver card
- Close card slot and push it in.

Setting activities

- Driving time (automatic when driving)
- * All other working times (Automatically when the vehicle is stopped for driver 1)
- Standby time (waiting times, co-driver time, driver 2 sleeping time during the journey)
- H Breaks and rest times
- **Driver 1/ Driver 2:** Press the combination key Driver-1 or Driver-2 repeatedly until the desired activity (H □ *) is shown in the display.

IMPORTANT

At the end of a shift or during a break, always set activity H.

Automatic setting after ignition on/off (option):

18:01* 0km/h
H 123456.7km H

Signalled by flashing of the activity for approx. 5 seconds in the standard display (a). Then, the previous display will appear again.

- As required, change the activity accordingly.

Reference to the operating instructions

IMPORTANT

These brief instructions shall not be regarded as a substitute for the exhaustive operating instructions for the DTCO 1381 prescribed by Regulation (EU) 2016/799, Annex IC.